

TX-2020A3FSA1-NG4DA-01

PRODUCT SPECIFICATION

Features:

Chip Material:

Emitting Color:

Applications:

--	--	--	--	--	--

Package Dimensions:

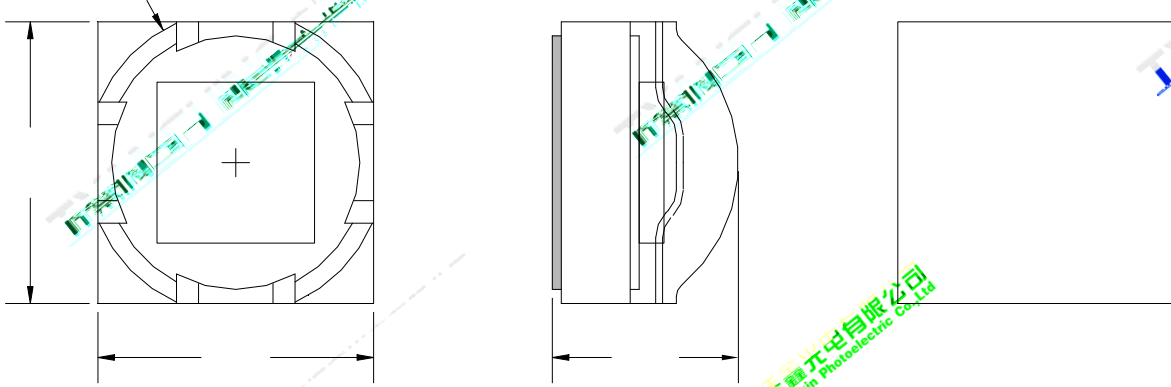

--	--	--	--	--	--

Electrical Optical Characteristics (Tc=25°C IF=0.35A)

White light Color coordinate filing (IF=0.35A)

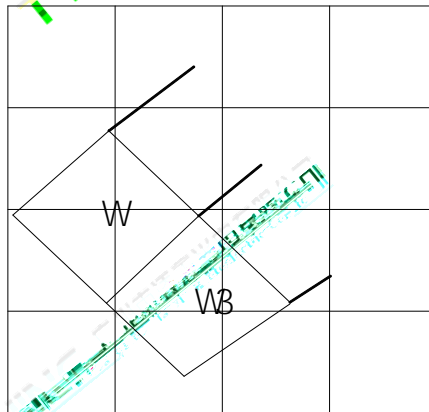

--	--	--	--	--	--

Typical Electrical/Optical Characteristics Curves

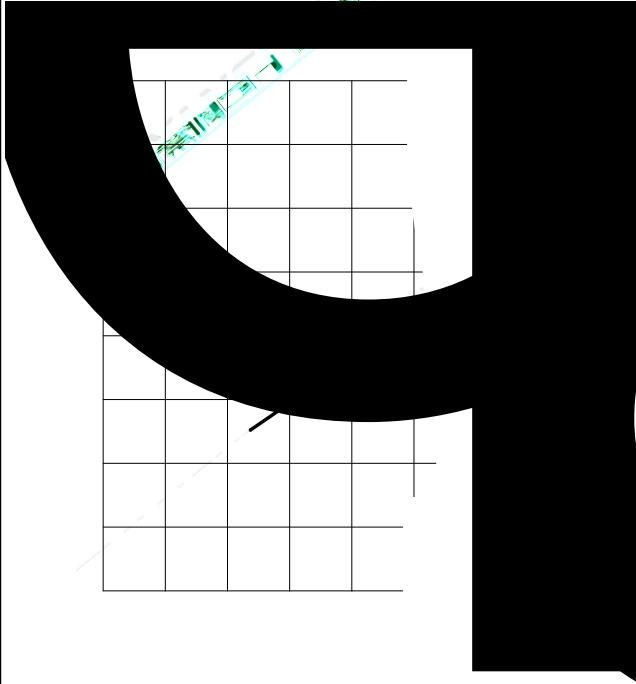

--	--	--	--	--	--

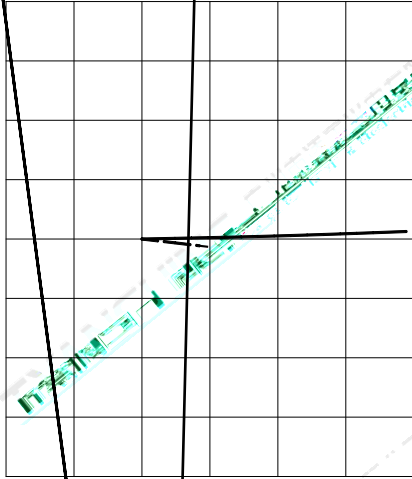

TYANSHINE 广州市添鑫光电有限公司
Guangzhou Tianxin Photoelectric Co.,Ltd

TYANSHINE 广州市添鑫光电有限公司
Guangzhou Tianxin Photoelectric Co.,Ltd

#

S

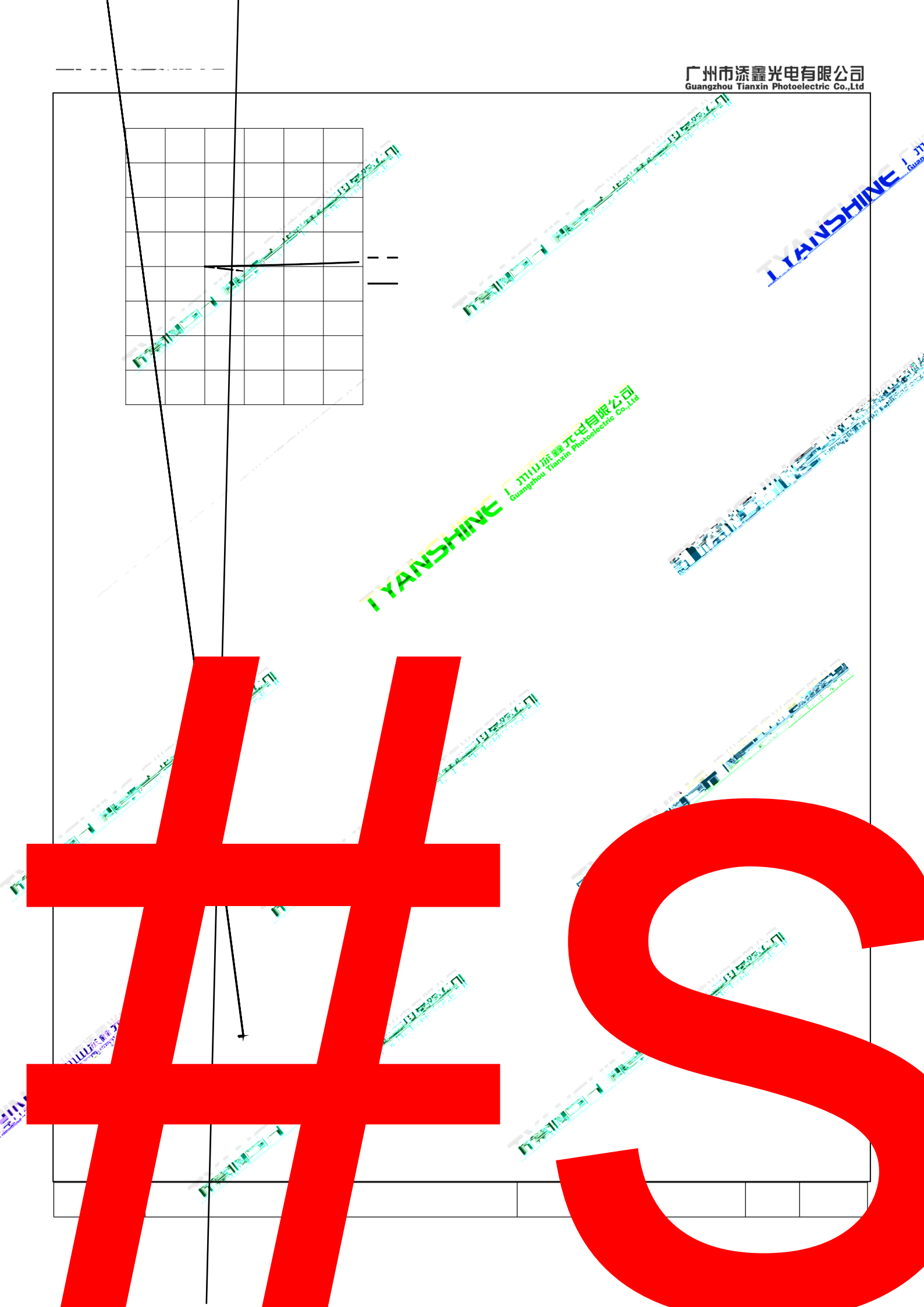

Usage Precautions

Storage Environment Condition

Soldering Condition

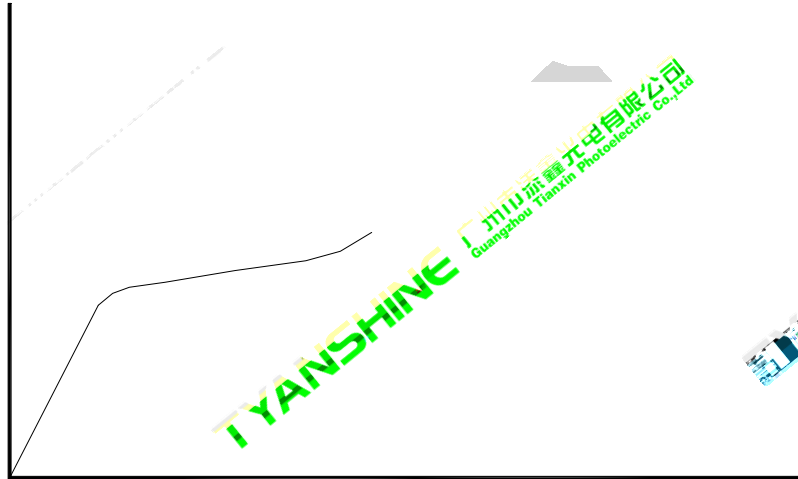

--	--	--	--	--	--

Dimensions For Cannulation And Packaging

Quantity:3000 PCS

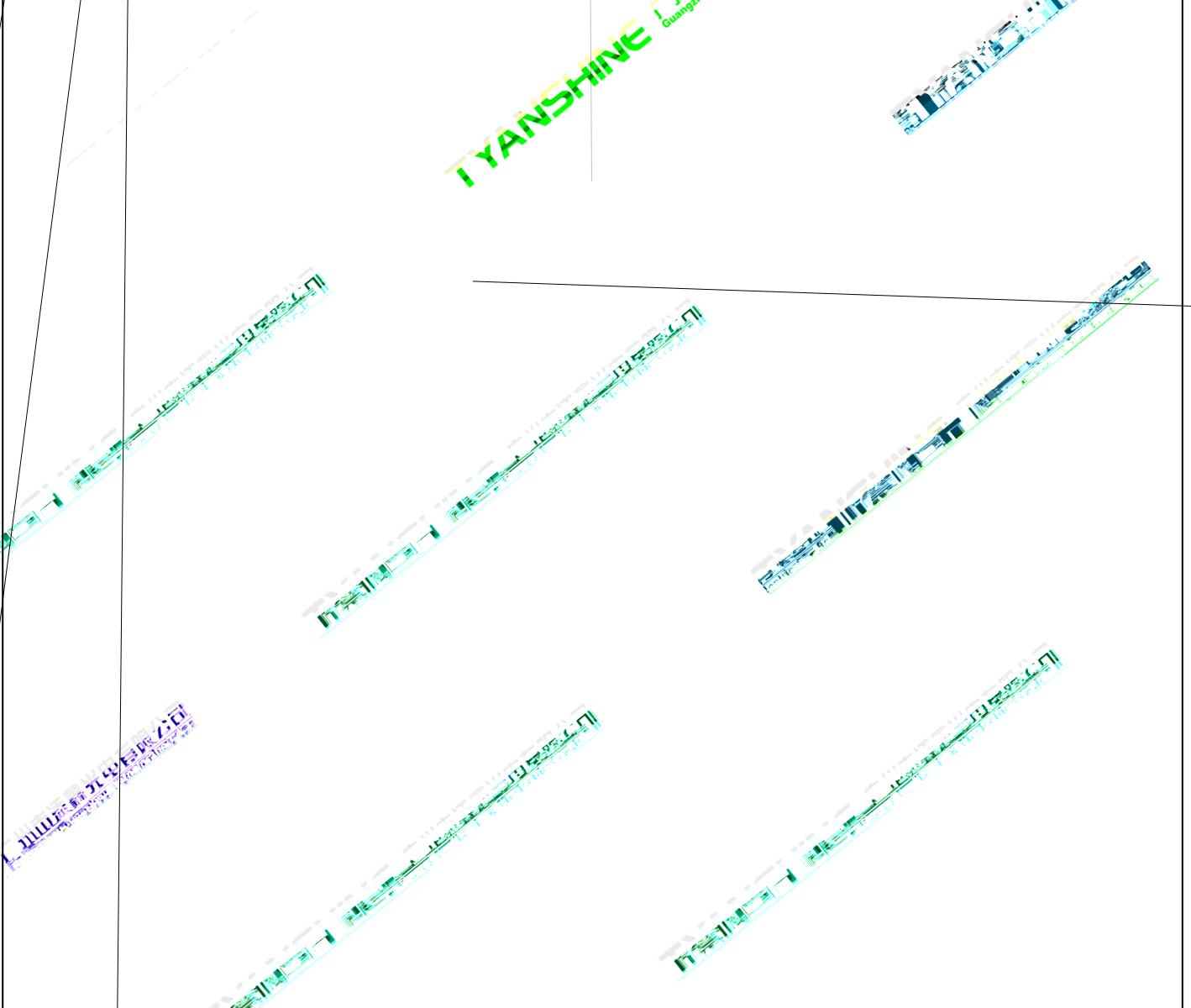

--	--	--	--	--	--