



CANEC24021252912

2024 10 09

1 10

15

LED

SGS

GZP24-031628

2024 09 24

2024 09 24 ~ 2024 09 29

RoHS	2011/65/EU	II	(EU) 2015/863-
(DEHP)	(PBB)	(PBDE)	(2-)
(DIBP)	(BBP)	(DBP)	
RoHS	2011/65/EU	II	(EU) 2015/863-

钟臻

Jany Zhong

scan to see the report

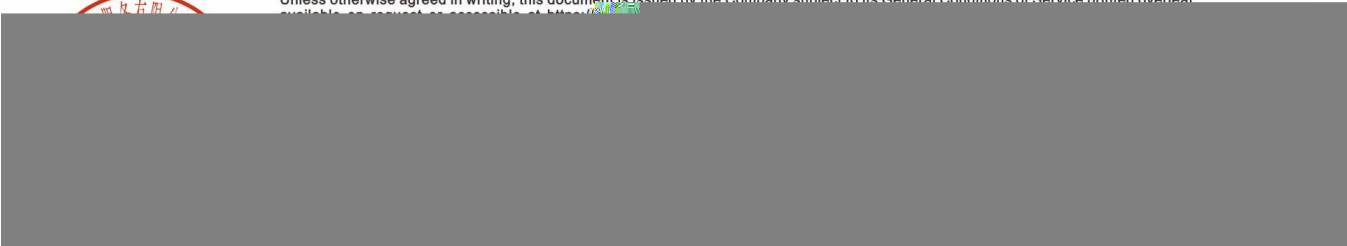

		SGS ID	
SN1	A20	CAN24-0212529-0001.C020	
SN2	A21	CAN24-0212529-0001.C021	
SN3	A22	CAN24-0212529-0001.C022	
SN4	A23	CAN24-0212529-0001.C023	
SN5	A24	CAN24-0212529-0001.C024	

(1) 1 mg/kg = 1 ppm = 0.0001%

(2) MDL=

(3) ND = (< MDL)

(4) "-" =

RoHS	2011/65/EU	II	(EU) 2015/863-	(PBB)
(PBDE)	(2-)	(DEHP)	(BBP)
(DBP)	(DIBP)			

IEC 62321-4:2013+AMD1:2017 IEC 62321-5:2013 IEC 62321-7-2:2017 IEC 62321-12:2023 ICP-OES/AAS UV-Vis GC-MS

			MDL	A20	A21
(Pb)	1000	mg/kg	2	ND	5
(Hg)	1000	mg/kg	2	ND	ND
(Cd)	100	mg/kg	2	ND	ND
(Cr(VI))	1000	mg/kg	8	ND	ND
(PBB)	1000	mg/kg	-	ND	ND
(MonoBB)	-	mg/kg	25	ND	ND
(DiBB)	-	mg/kg	25	ND	ND
(TriBB)	-	mg/kg	25	ND	ND
(TetraBB)	-	mg/kg	25	ND	ND
(PentaBB)	-	mg/kg	25	ND	ND
(HexaBB)	-	mg/kg	25	ND	ND
(HeptaBB)	-	mg/kg	25	ND	ND
(OctaBB)	-	mg/kg	25	ND	ND
(NonaBB)	-	mg/kg	25	ND	ND
(DecaBB)	-	mg/kg	25	ND	ND
(PBDE)	1000	mg/kg	-	ND	ND
(MonoBDE)	-	mg/kg	25	ND	ND

			MDL	A20	A21
(DiBDE)	-	mg/kg	25	ND	ND
(TriBDE)	-	mg/kg	25	ND	ND
(TetraBDE)	-	mg/kg	25	ND	ND
(PentaBDE)	-	mg/kg	25	ND	ND
(HexaBDE)	-	mg/kg	25	ND	ND
(HeptaBDE)	-	mg/kg	25	ND	ND
(OctaBDE)	-	mg/kg	25	ND	ND
(NonaBDE)	-	mg/kg	25	ND	ND
(DecaBDE)	-	mg/kg	25	ND	ND
(2-) (DEHP)	1000	mg/kg	50	ND	ND
(BBP)	1000	mg/kg	50	ND	ND
(DBP)	1000	mg/kg	50	ND	ND
(DIBP)	1000	mg/kg	50	ND	ND

- (1) RoHS (EU) 2015/863
(2) IEC 62321 EN 62321
(3) 2021 7 22 DEHP BBP DBP DIBP

IEC 62321-4:2013+AMD1:2017 IEC 62321-5:2013 IEC 62321-7-2:2017 IEC 62321-12:2023 ICP-OES/AAS UV-Vis GC-MS

			MDL	A24
(Pb)	1000	mg/kg	2	ND
(Hg)	1000	mg/kg	2	ND
(Cd)	100	mg/kg	2	ND
(Cr(VI))	1000	mg/kg	8	ND
(PBB)	1000	mg/kg	-	ND
(MonoBB)	-	mg/kg	25	ND
(DiBB)	-	mg/kg	25	ND
(TriBB)	-	mg/kg	25	ND
(TetraBB)	-	mg/kg	25	ND
(PentaBB)	-	mg/kg	25	ND
(HexaBB)	-	mg/kg	25	ND
(HeptaBB)	-	mg/kg	25	ND
(OctaBB)	-	mg/kg	25	ND
(NonaBB)	-	mg/kg	25	ND
(DecaBB)	-	mg/kg	25	ND
(PBDE)	1000	mg/kg	-	ND
(MonoBDE)	-	mg/kg	25	ND
(DiBDE)	-	mg/kg	25	ND
(TriBDE)	-	mg/kg	25	ND

			MDL	A24
(TetraBDE)	-	mg/kg	25	ND
(PentaBDE)	-	mg/kg	25	ND
(HexaBDE)	-	mg/kg	25	ND
(HeptaBDE)	-	mg/kg	25	ND
(OctaBDE)	-	mg/kg	25	ND
(NonaBDE)	-	mg/kg	25	ND
(DecaBDE)	-	mg/kg	25	ND
(2-) (DEHP)	1000	mg/kg	50	ND
(BBP)	1000	mg/kg	50	ND
(DBP)	1000	mg/kg	50	ND
(DIBP)	1000	mg/kg	50	ND

- (1) RoHS (EU) 2015/863
 (2) IEC 62321 EN 62321
 (3) 2021 7 22 DEHP BBP DBP DIBP

RoHS 2011/65/EU II (EU) 2015/863-

IEC 62321-4:2013+AMD1:2017 IEC 62321-5:2013 IEC 62321-7-1:2015 ICP-
 OES/AAS UV-Vis

			MDL	A22	A23
(Pb)	1000	mg/kg	2	6	36
(Hg)	1000	mg/kg	2	ND	ND
(Cd)	100	mg/kg	2	ND	ND
(Cr(VI))	-	µg/cm ²	0.10	ND	ND

- (1) RoHS (EU) 2015/863
 (2) IEC 62321 EN 62321
 (3) = a. 0.13 µg/cm²
 b. ND (0.10 µg/cm²)
 c. 0.10 µg/cm² 0.13 µg/cm²

A24

ILAC-G8:09/2019

w=0

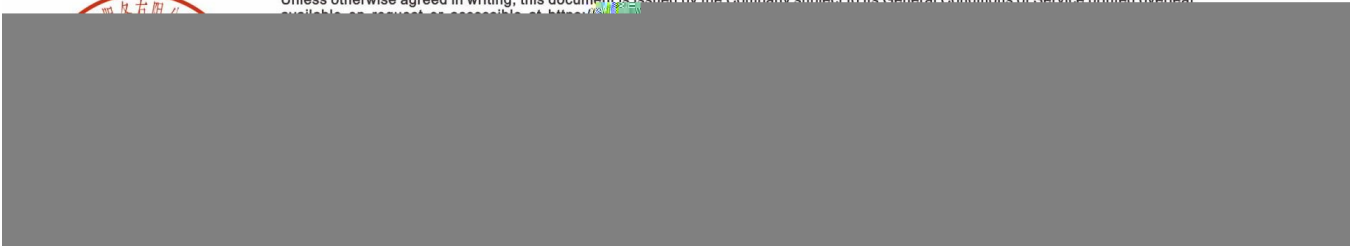
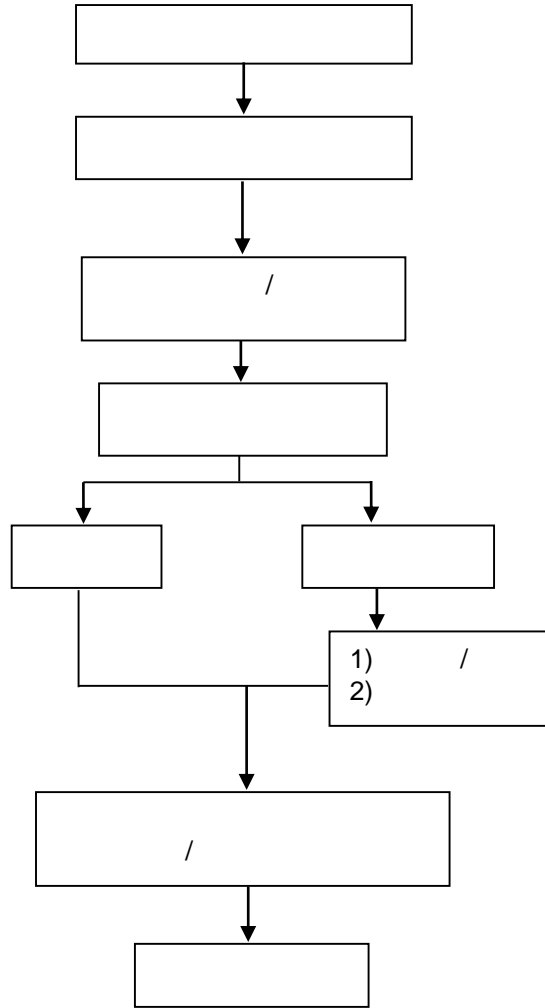

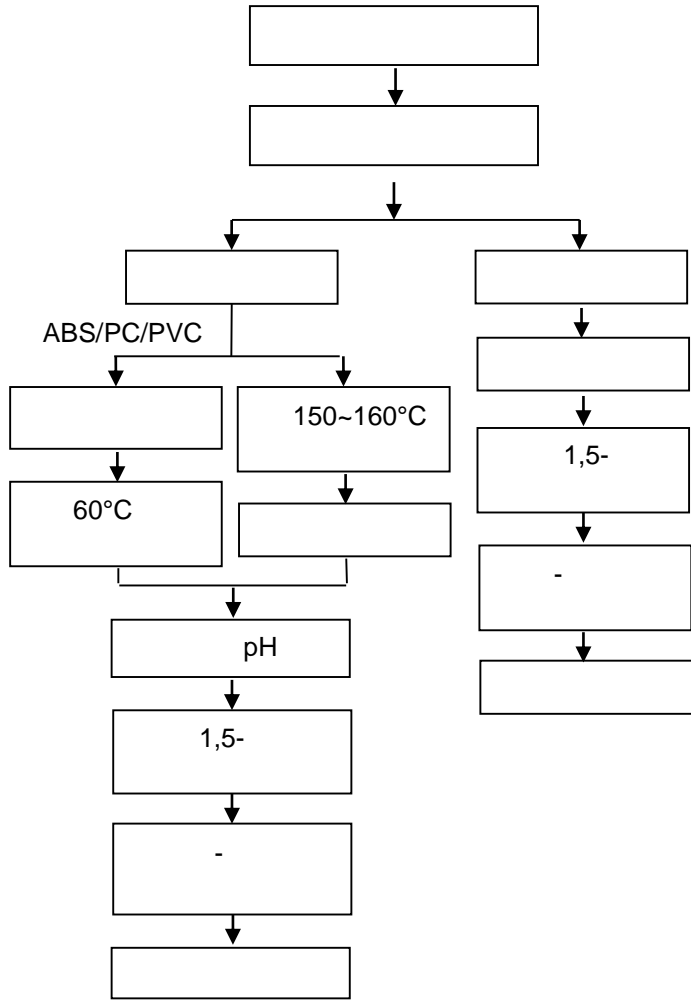



PBB/PBDE/Phthalates

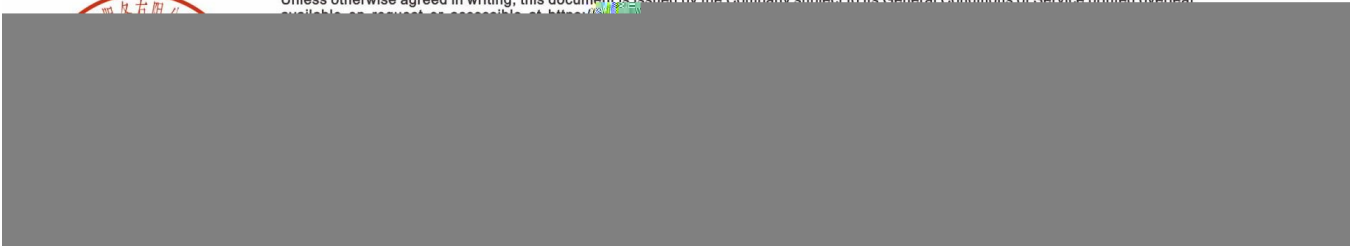

CANEC24021252912

2024 10 09

8

10

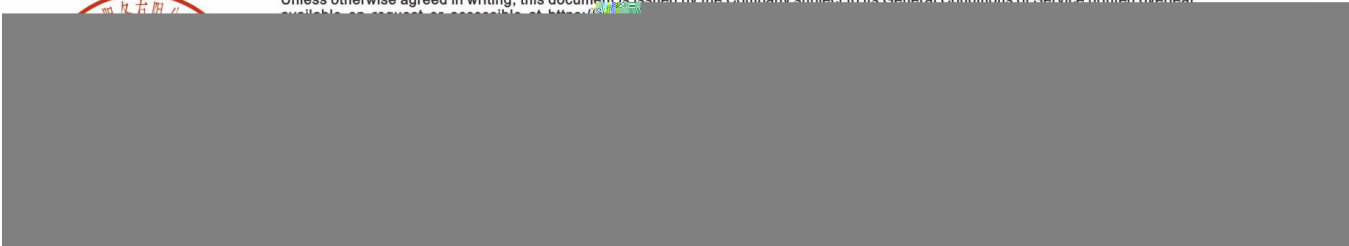
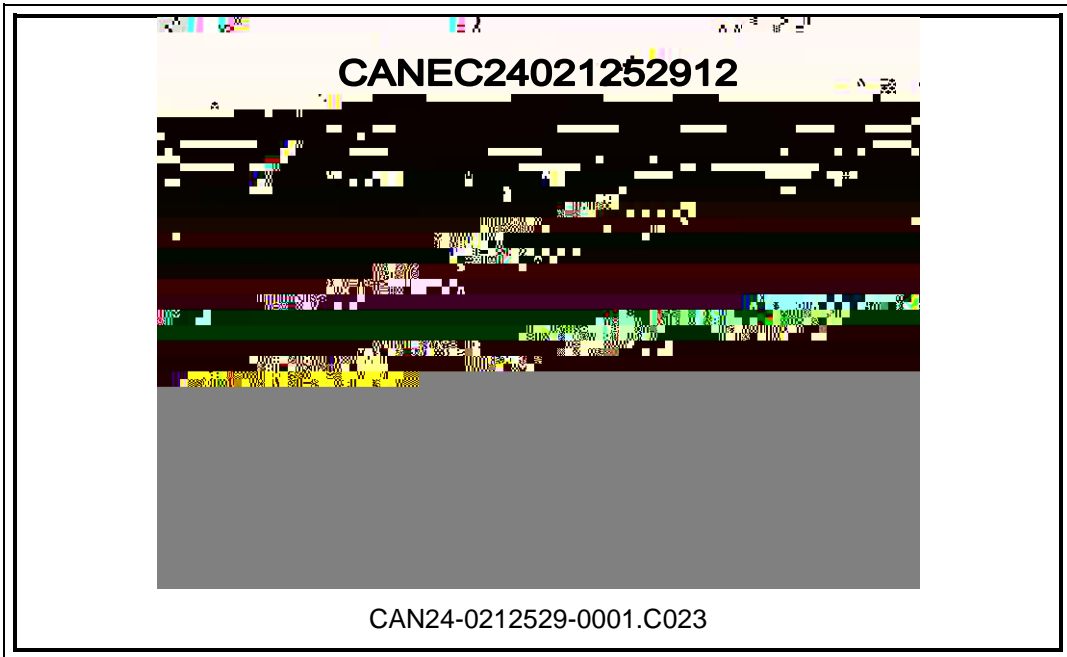



CANEC24021252912

2024 10 09

10

10

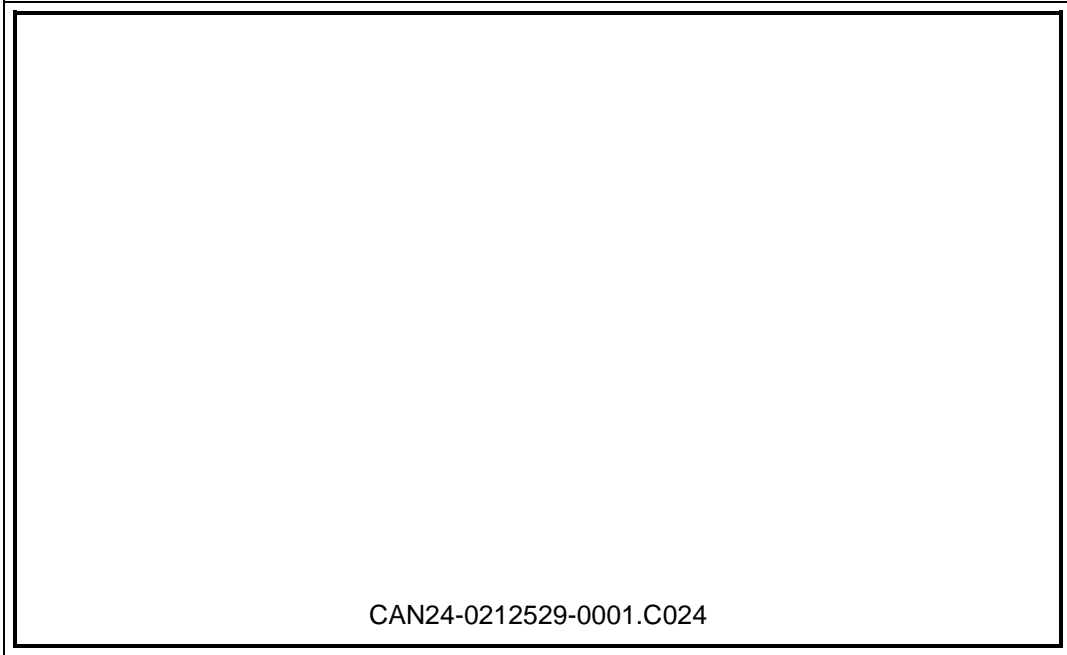

CAN24-0212529-0001.C024

